

Article number: 20128260AL

Description: E+G Hinge for weld mounting GN 128.2-60-AL
Aluminium hinge/pin stainless 1.4301

Measures

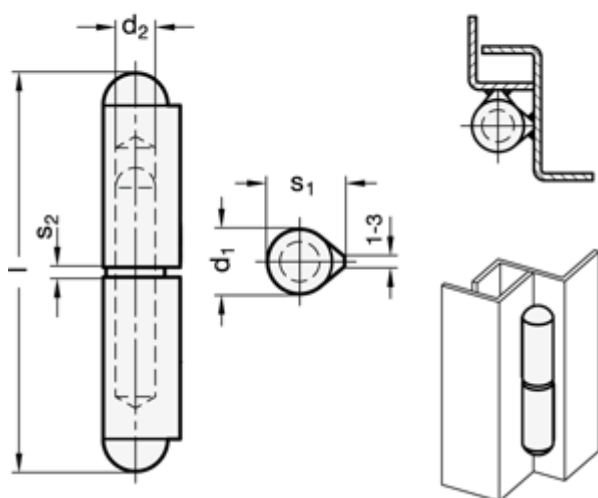

d1	= 10
d2	= 6
Length l	= 60
s1	= 12.0
s2	= 2